

DESIGN VENTILASI INDUSTRI ASBESTOS



Ir. MUH. ARIF LATAR, MSc

1.1 DATA AWAL

1. Industri asbestos, dengan jenis bahan serat crysotile

2. Unit produksi pada unit Crusing, dengan data sebagai berikut :
 - Tipe hood enclosure
 - Generation rate ----- 200 fiber/cc/60 menit
 - TLV-TVWA (asbestos) ----- 2 fiber/cc
 - Faktor K ----- 2
 - Volume ruang ($8 \times 7 \times 3 = 168 \text{ m}^3$)-----.....5.880 ft³
 - Air flow slots velocity ----- 400 fpm
 - Duct velocity ----- 3.500. fpm

3. Elbow
 - R/D = 2
 - loss coefisien: ----- 0,24

4. Entry
 - Entry sudut $\emptyset = 30^0$
 - Entry loss coefisien ----- 0,28

1.2. BENTUK DAN LAY PROSES OPERASI RUANG KERJA

Pertimbangan desain sangat tergantung bentuk dan lay out peores operasi, ruang kerja dan bentuk kontruksi bangunan

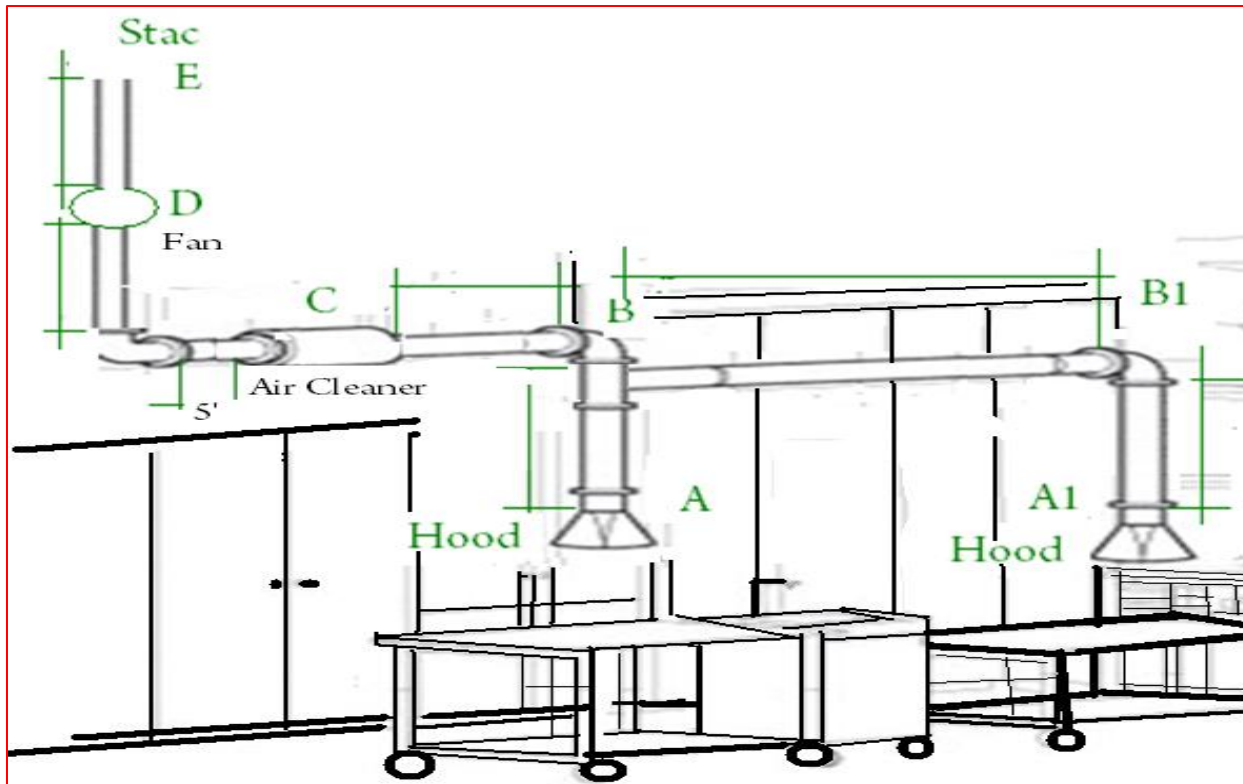

Gambar -1 : BENTUK KONTRUKSI BANGUNAN

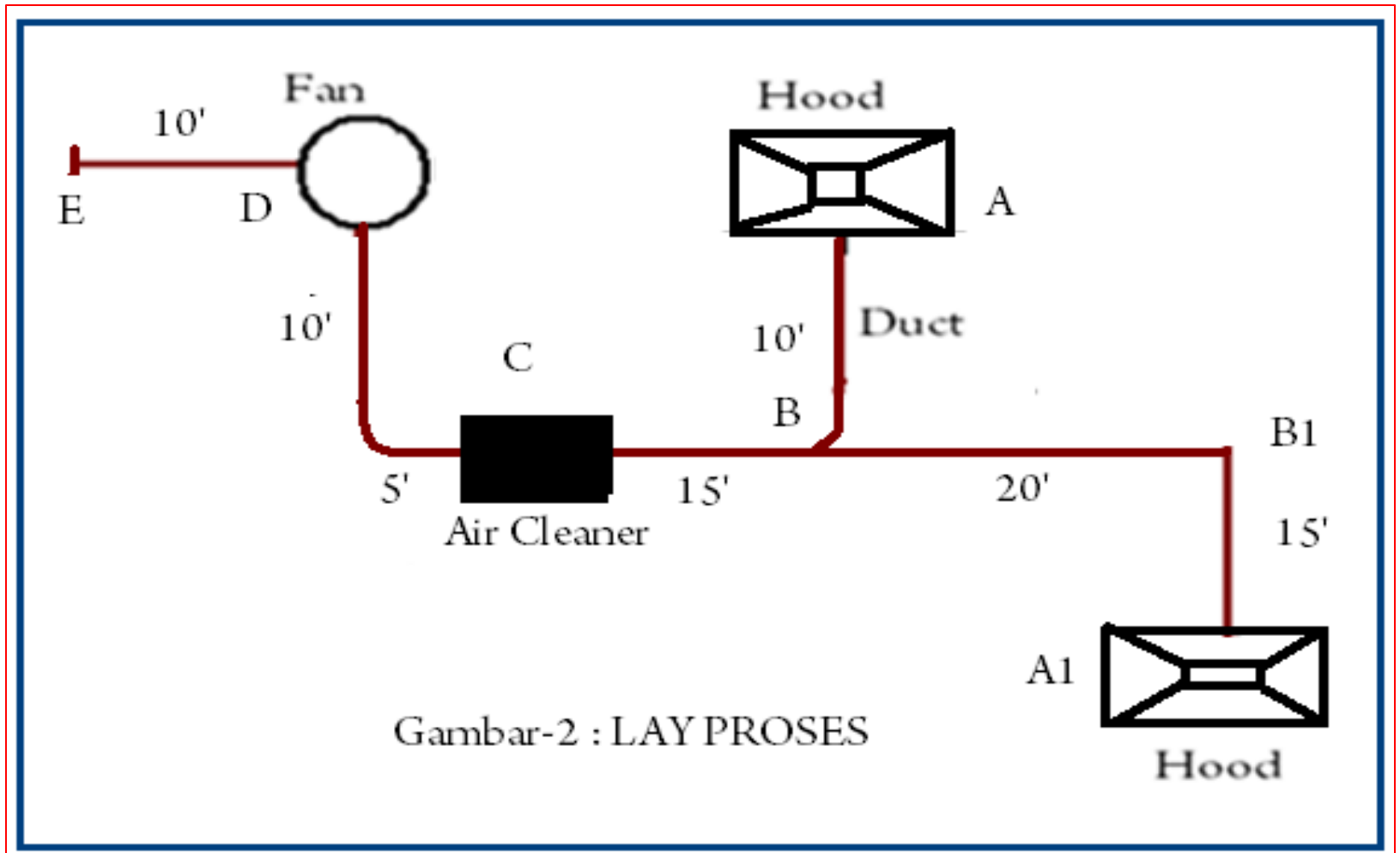

Gambar – 2 : SKEMA SISTEM SALURAN PIPA

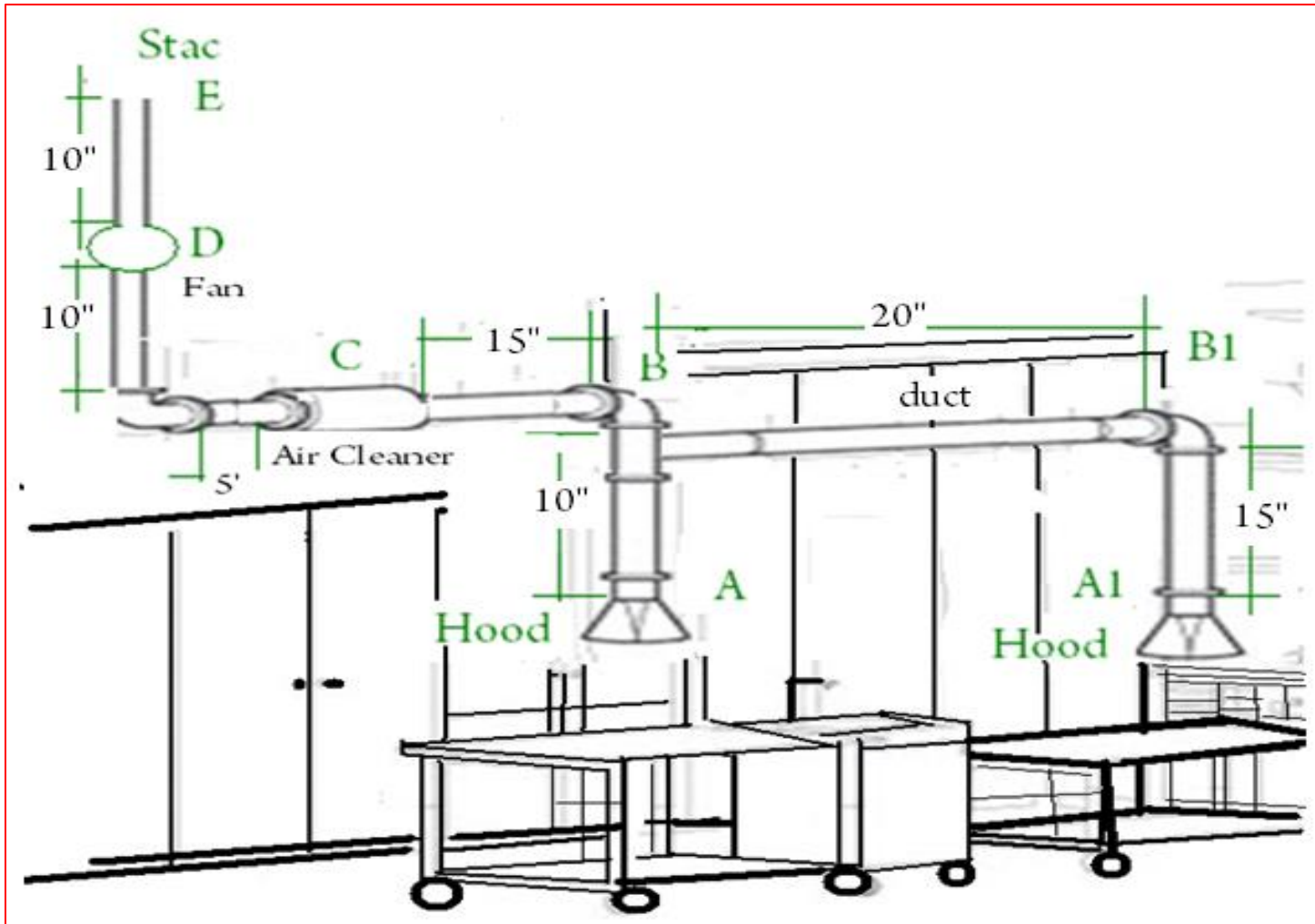

Gambar- 3 : UKURAN LAY PROSES OPERASI

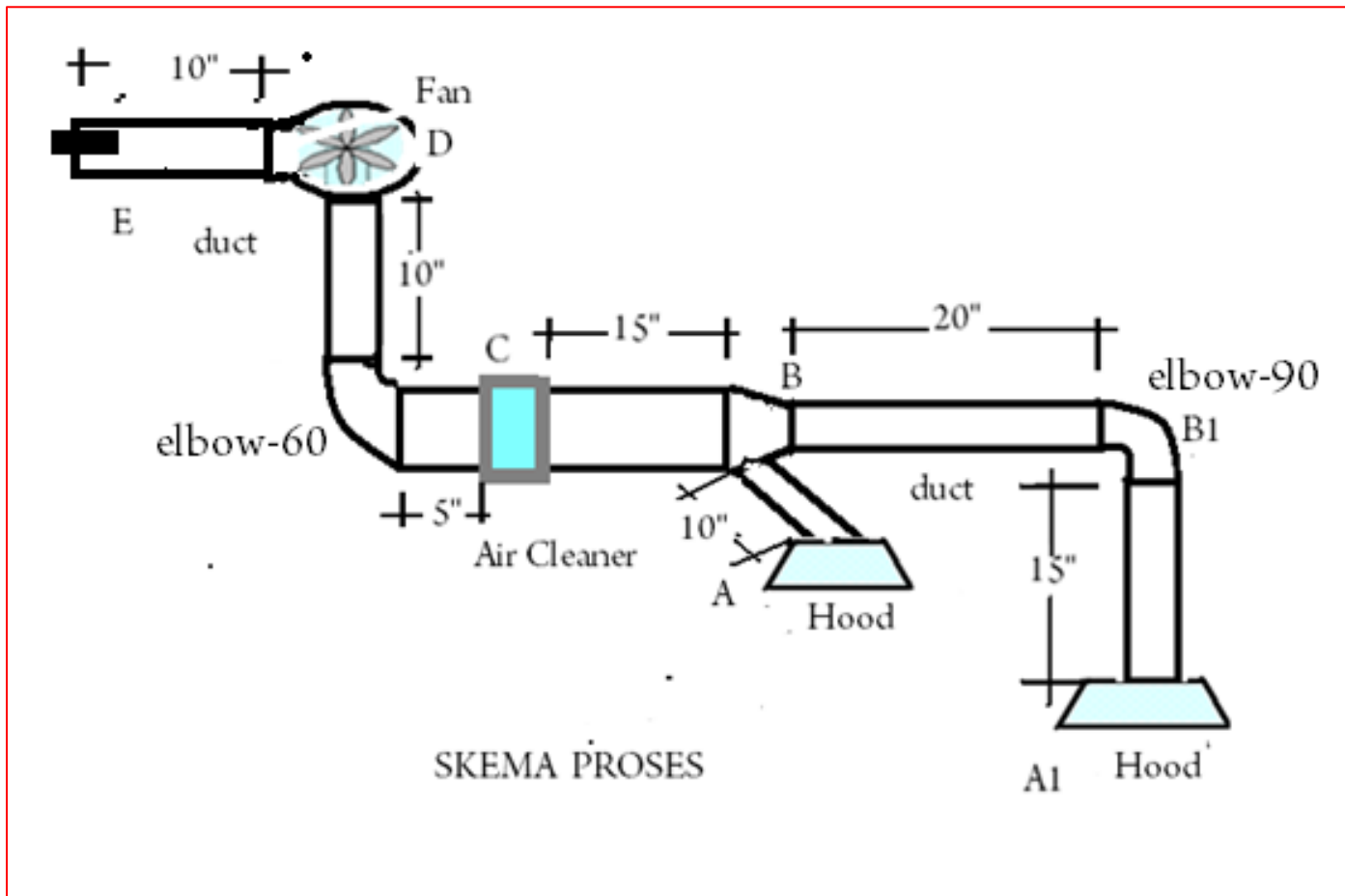

Gambar – 4 : BENTUK DESAIN VENTILASI

2.2.. PENENTUAN DEMENSI

Dari data awal yang diketahui dan bentuk dan ukuran konstruksi bangunan pada gambar 1 s/d gambar 4, maka ditetapkan sebagai berikut, pada table- 1.1.

Tabel- 1.1. Ukuran nomor detail, flow rate, diameter dan panjang pipa , elbow dan enteries

Nomor Detail	Cfm Required	Duct Diameter inches	Panjang/ Strainght Run, ft	Elbows	Entries
A1-B1	4500	19	15		
B1-B	4500	19	20		
A1- B	4500	19	35	1 - 90 ⁰	1 - 30 ⁰
A – B	3600	13.	10	1 - 30 ⁰	1 - 30 ⁰
B – C	19.600	29	15		
C (air cleaner)					
C – D	19.600	29	15	1 - 60 ⁰	1 - 30 ⁰
D (fan)	19.600	33			
D – E	19.600	30.	10		

II. PENENTUAN UKURAN –UKURAN UTAMA

2.1. PENENTUAN FLOW RATE SUPPLY (Q)

Untuk menghitung flow rate di gunakan rumus :

$$Q = \frac{\text{volume ruang} \times \text{generation rate} \times K}{\text{TLV}}$$

$$Q = \frac{(5.880 \times 200) / 60 \times 2}{2}$$

$$Q = 19.600 \text{ cfm}$$

Dimana :

Volume ruang	=	5.880 ft ³
TLV	=	2 fiber/cc
Generation rate	=	200 fiber/cc/60 menit
Faktor K	=	2

3.2. PEMELIHAN ALTERNATIF BRANCH ENTRY

Pemilihan alternative bentuk brach entry tergantung pada bentuk kontruksi, saluran pipa yang diinginkan , pada desain ini diambil bentuk prefereddengan sudut maximal $\theta = 30^\circ$, gambar 5.28 indutrial ventilation ACGIH edition 20. Ukuran data yang diambil seprti digambarkan pada Gambar – 6,

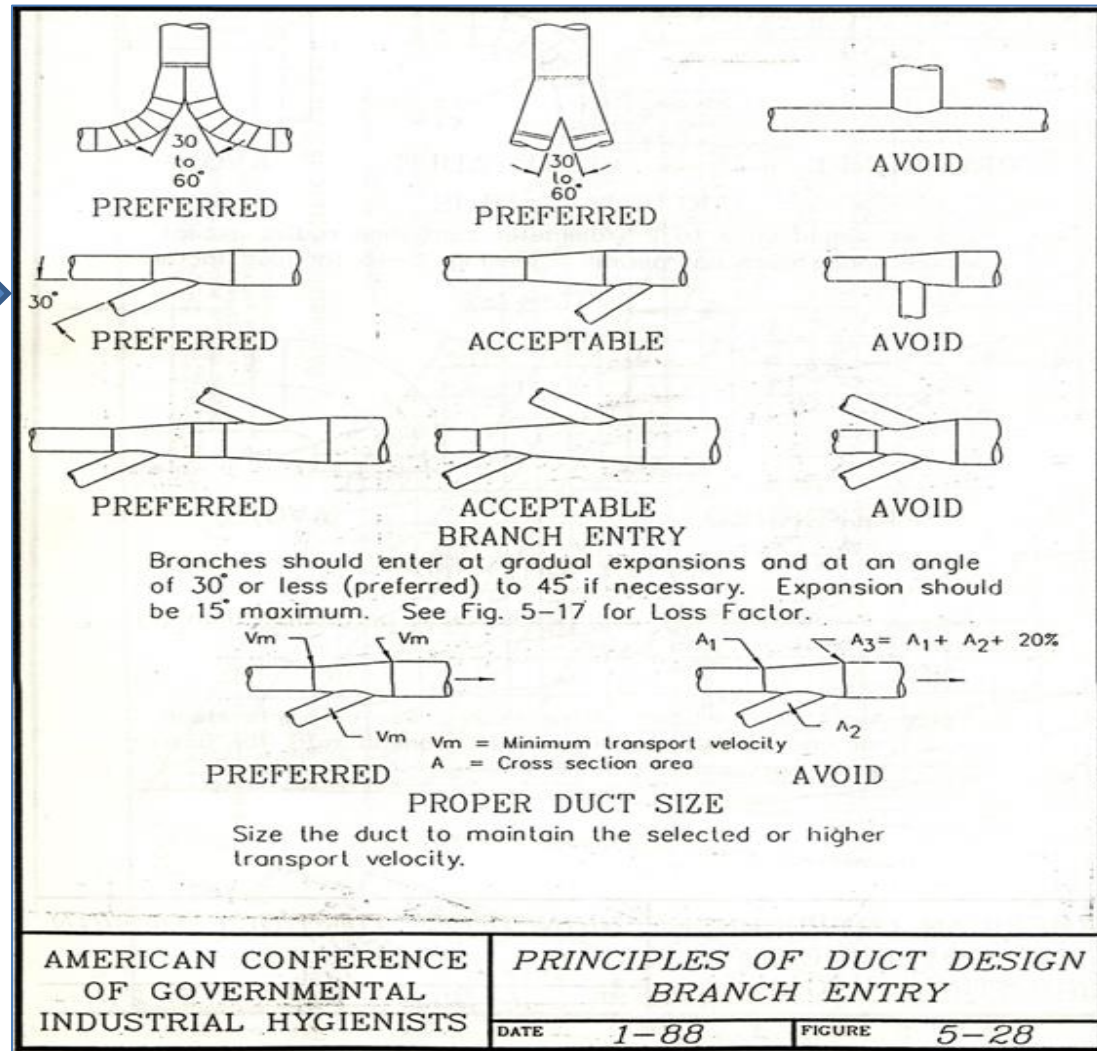
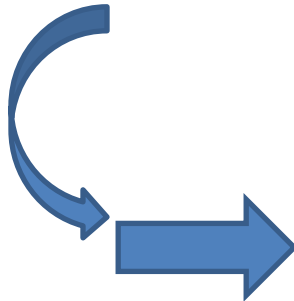

III. DESAIN PROSEDUR

3.1. DESAIN DUCT

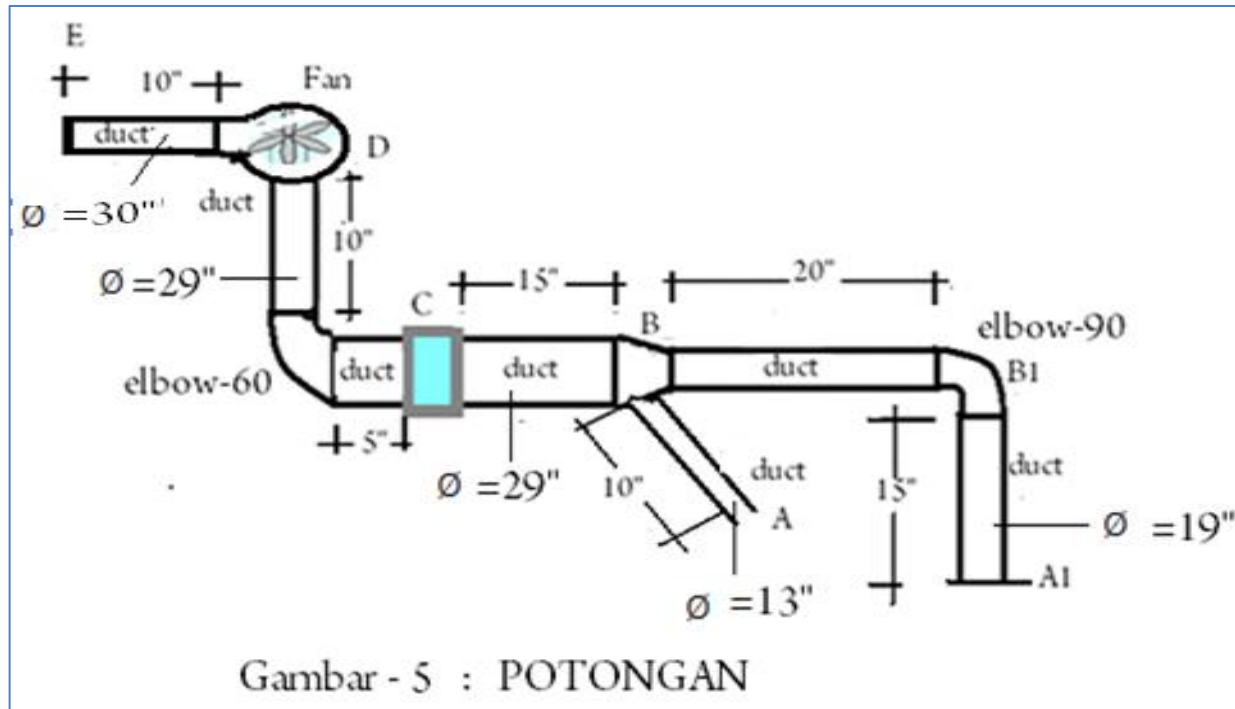

UKURAN	POTONGAN				
	A1 - B	A - B	B - C	C - D	D - E
Diameter (inci)	19	13	29	29	30
Panjang (ft)	35	10	15	15	10

3.3.. DESAIN DETAIL HOOD - SLOT

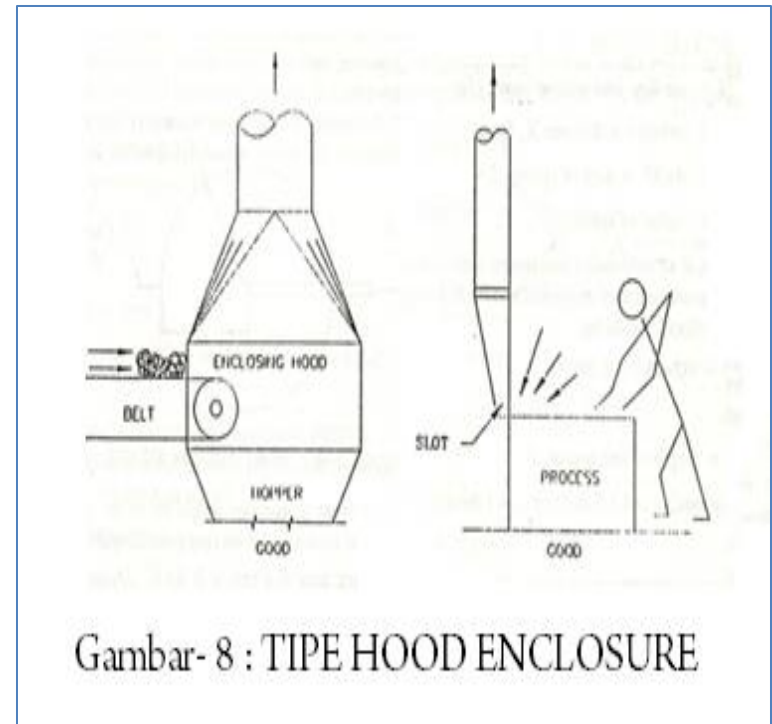
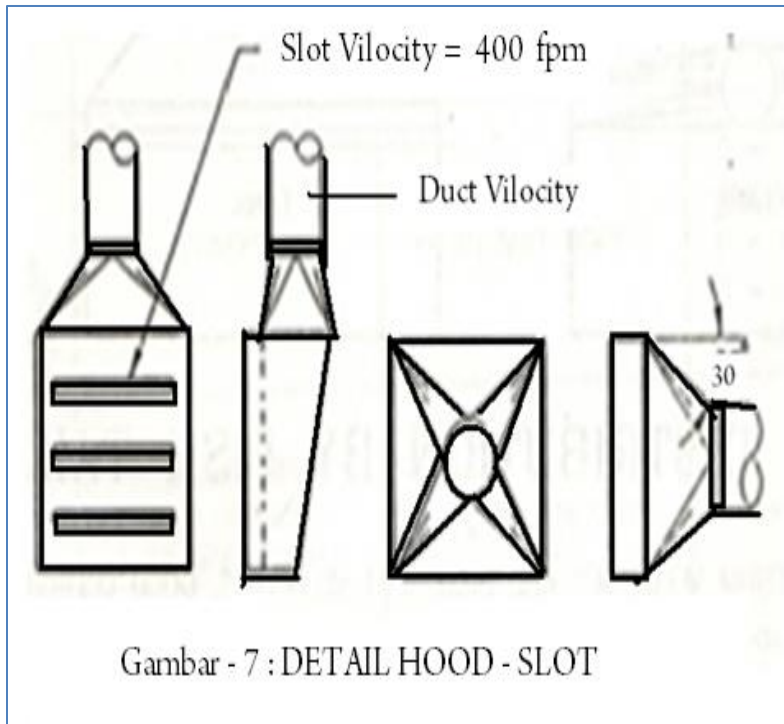

IV. PERHITUNGAN

Metode perhitungan yang digunakan dalam desain ini adalah menggunakan metode desain Perhitungan Kecepatan Tekanan atau Velocity Pressure Method Calculation Sheet

4.1. METODE KECEPATAN TEKANAN

Dari hasil perhitungan yaitu untuk mengetahui distribusi volume flow rate, duct velocity, slot velocity, slot static pressure, hood static pressure, duct SP loss, dan kumulatif static pressure, Fan SP dan Fan TP. Dengan data hasil perhitungan besar daya , dan putaran Fan yang akan digunakan.

4.1.1. Hasil Perhitungan

Velocity Pressure Method Calculation Sheet

Plant Name: **CONTOH TUGAS** Elevation: _____ Date: 15 januari 2011
 Location: _____ Temp: _____ Drawing #: _____
 Department: _____ + Factor: _____ Designer: _____

1	Duct Segment Identification		A1-B	A-B	B - C	C	C - D	D	D-E
2	Target Volume Flowrate, $Q = V \cdot A$ - Chap 10	cfm	4500.0	3600.0	19600.0	19600.0	19600.0	19600.0	19600.0
3	Min. Transport Velocity, V Chap 10	fpm	3500	3500					
4	Maximum Duct Diameter ($D = ((4 \cdot 144 \cdot Q) / (\pi \cdot V))^{0.5}$)	inches	19.00	13.00	29.00	A	29.00	33.00	30.00
5	Selected Duct Diameter	inches	19.00	9.00	29.00	I	29.00		30.00
6	Duct Area ($\pi \cdot (D/12)^2 / 4$)	sq. ft	1.9689	0.9218	4.5869	R	4.5869	5.9396	4.9087
7	Actual Duct Velocity	fpm	2285.5	3905.6	4273.0		4273.0	3299.9	3992.9
8	Duct Velocity Pres, $VP = (V/4005)^2$	"wg	0.3256	0.9510	1.1383	C	1.1383	0.6789	0.9940
9	H Maximum Slot Area = (2/11)	sq ft				L			
10	O Slot area selected	sq ft				E		F	
11	O S Slot Velocity, V_s Chap 10	fpm	400.00	400.00		A		A	
12	D L Slot Velocity Pres, $VP_s = (V_s/4005)^2$	"wg	0.0100	0.0100		N		N	
13	O Slot Loss Coefficient, Chap 10, Chap 3		1.78	1.78		E			
14	T Acceleration Factor	0 or 1	0	0		R			
15	S S Slot Loss per VP (13+14)		1.78	1.78					
16	U Slot Static Pressure (12*15)	"wg	0.0178	0.0178					
17	C Duct Entry Loss Factor F5-12, Chap 10		0.250	0.250	0.250		0.250		0.250
18	T Acceleration Factor (1 at hoods)	1 or 0	1	1	1		1		1
19	I Duct Entry Loss per VP (17 + 18)		1.25	1.25	1.25		1.25		1.25
20	O Duct Entry Loss (8 * 19)	"wg	0.407	1.189	1.423		1.423		1.242
21	N Other Losses	"wg				0.400			
22	Hood Static Pressure SPh (16+20+21)	"wg	0.425	1.206	1.423	0.400	1.423		1.242
23	Straight Duct Length	ft	35.0	10.0	15.0		15.0		10.0
24	Friction Factor (Hf)		0.0110	0.0168	0.0062		0.0062		0.0060
25	Friction Loss per VP (23 * 24)		0.3853	0.1679	0.0937		0.0937		0.0602
26	No. of 90 degree Elbows		1.00	0.18			0.44		
27	Elbow Loss Coefficient (Bottom of Page)		0.24	0.24			0.24		
28	Elbow Loss per VP (26*Loss Factor)(bottom of page)		0.2400	0.0432			0.1056		
29	No. of Branch Entries (1 or 0)		1.00	1.00	1.00		1.00		1.00
30	Entry Loss Coefficient		0.28	0.28	0.28		0.28		0.28
31	Entry Loss per VP (29*Loss Factor) (Branch)		0.28	0.28	0.28		0.28		0.28
32	Special Fittings Loss Factors								
33	Duct Loss per VP (25 + 28 + 31 + 32)		0.9053	0.4911	0.3737		0.4793		0.3402
34	Duct Loss (8*33)		0.2948	0.4670	0.4253		0.5455		0.3382
35	Duct SP Loss (22 + 34)		0.720	1.674	1.848	0.400	1.968		1.581
36	Other Losses								
37	Cumulative Static Pressure	"wg	-0.720	-1.674	-1.848	-2.248	-4.216		5.797
38	Governing Static Pressure (at TO location)	"wg	-1674.000	-1.848					
39	Corrected Volumetric Flowrate	cfm							
40	Corrected Velocity	fpm							
41	Corrected Velocity Pressure	"wg							
42	Resultant Velocity Pressure	"wg							

4.1.2. Hasil Perhitungan Brach Entry

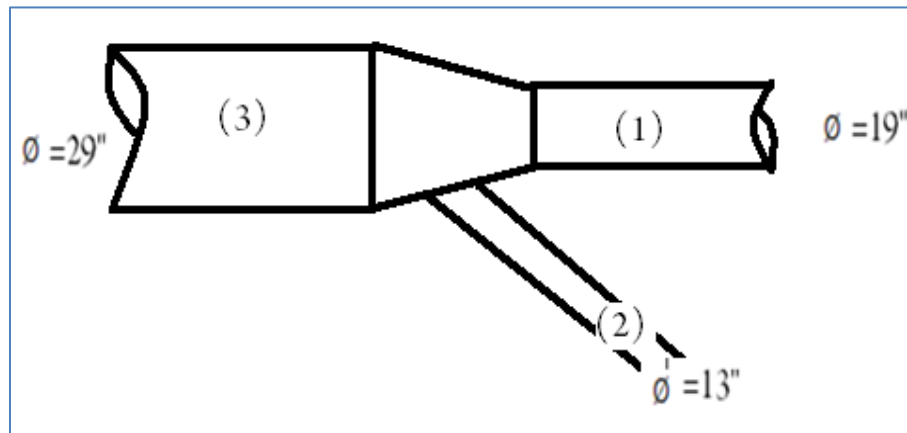

No, Duct	Diameter (inci)	Duct Area (sq.ft)	Q (cfm)	V (fpm)	VP ("wg)	SP ('wg)
(1) = A1 – B	19	1,9689	4500	2285,5	0,3256	-0,720
(2) = A – B	13	0,9218	3600	3905,6	0,9510	-1,674
(3) = B - C	29	4,5869	19.600	4273,0	1,1383	-1,848
FSP-----8,8747 "wg			BHP ---- 10,14 hp			
FTP-----9,8687 "wg			RPM ----- 1894			
Daun Propeler/jumlah blades (n) = 3			Hz			
Data	Bln, Januari	Th, 2011	Dapertemen	Produksi		

V. PERHITUNGAN DAYA FAN

Data yang diperlukan untuk menentukan besarnya daya HP= House Power dan Putaran (rpm), Fan yang digunakan dalam desain ini adalah :

- ✓ N = jumlah blades,
- ✓ Q=volumetric flow rate,
- ✓ FSP = Fan Static Pressure,
- ✓ FTP = Fan Total Pressure

Rumus yang digunakan sebagai berikut :

$$FSP = SP_{out\ let} - SP_{in\ let} - VP_{inlet}$$

$$FTP = FSP + VP_{out\ let}$$

$$BHP = (FTP * Q)/(6356*n)$$

Dari hasil perhitungan pada hasil perhitungan dengan data sbb :

- $SP_{out\ let} = 5,797$ "wg
- $SP_{in\ let} = -4,216$ "wg
- $VP_{in\ let} = 1,1383$ "wg
- $VP_{out\ let} = 0,9940$ "wg
- $Q = 19.600$ cfm
- $N = 3$

$$FSP = 5,797 - (-4,216) - 1,1383$$

$$FSP = 8,8747 \text{ "wg}$$

$$FTP = 8,8747 + 0,9940$$

$$FTP = 9,8687 \text{ "wg}$$

$$BHP = \frac{(9,8687 \times 19.600)}{(6356 \times 3)}$$

$$BHP = 10,14 \text{ HP}$$

$$RPM = 1894$$

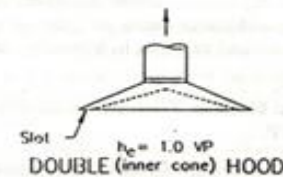
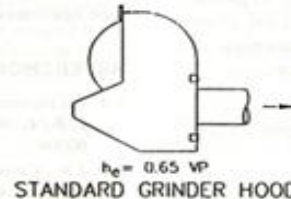
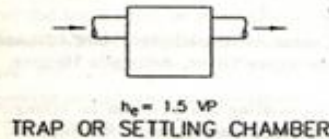
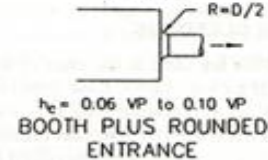
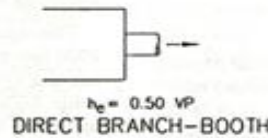
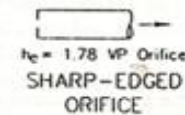
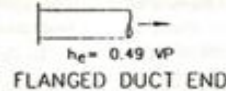
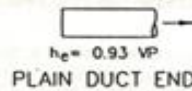

Reproduced by permission from "Industrial Health Engineering" by A.D. Brandt, published by John Wiley and Sons, Inc.

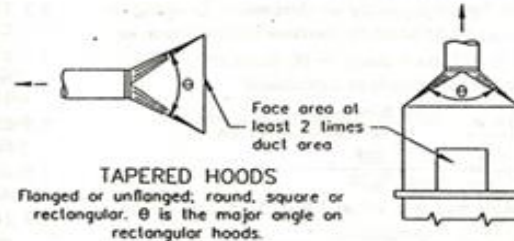
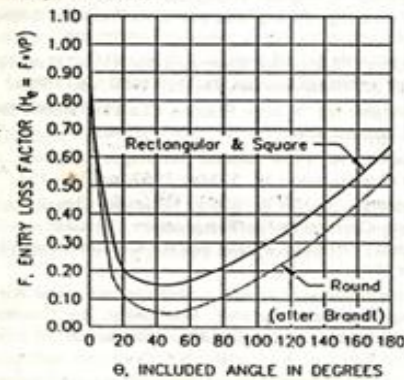

θ	ENTRY LOSS	
	ROUND	RECTANGULAR
15°	0.15 VP	0.25 VP
30°	0.08 VP	0.16 VP
45°	0.06 VP	0.15 VP
60°	0.08 VP	0.17 VP
90°	0.15 VP	0.25 VP
120°	0.26 VP	0.35 VP
150°	0.40 VP	0.48 VP

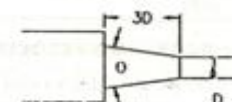

HOOD	ENTRY LOSS, F
Abrasive blast chamber	1.0
Abrasive blast elevator	2.3
Abrasive separator	2.3
Elevators (enclosures)	0.69
Flanged pipe plus close elbow	0.8
Plain pipe plus close elbow	1.60

VP = Velocity Pressure in Duct
SP = Static Pressure at Throat, "wg
 h_e = Entry Loss, "wg
Q = Volumetric Flowrate, cfm
A = Cross Section at Throat, ft²

AMERICAN CONFERENCE
OF GOVERNMENTAL
INDUSTRIAL HYGIENISTS

HOOD ENTRY LOSS FACTORS

Terima Kasih

